

Varenummer: 20477B10ELS
Beskrivelse: E+G Rørholder - GN 477-B10-ELS

Mål

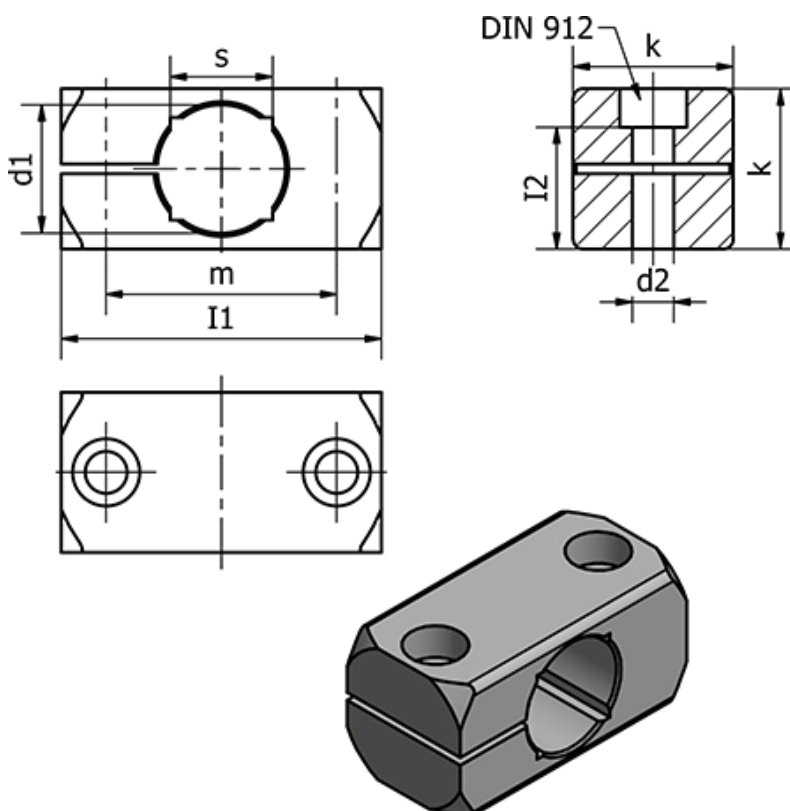

$d1$ = 10

$d2$ = M5

Fastspændings kit for $d2$ = GN 511-M5-25

Fastspændings kit for $d3$ = -

$l1$ = 38

$l2$ = 10.5

k = 16

m = 27

s = 8

Vægt (g) = 18